

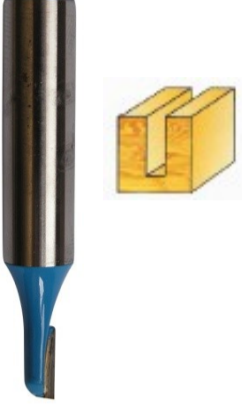











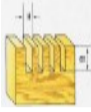



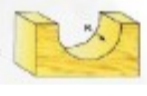

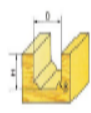

Stopkové frézy do dreva s upínacou stopkou 8 mm

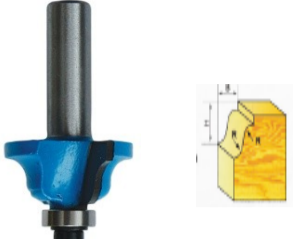

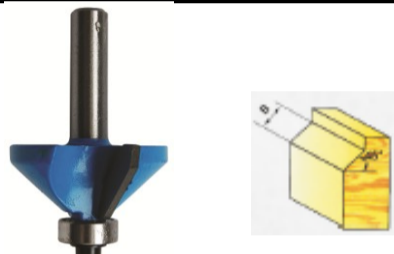
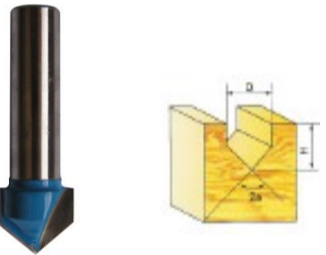

		<table border="1"> <thead> <tr> <th>kód</th> <th>popis</th> </tr> </thead> <tbody> <tr> <td>WJ 02 001L</td> <td>D=6; H 31,75 mm</td> </tr> <tr> <td>WJ 02 002L</td> <td>D=8; H 33 mm</td> </tr> <tr> <td>WJ 02 003L</td> <td>D=10; H 38,1 mm</td> </tr> <tr> <td>WJ 02 004L</td> <td>D=12; H 38,1 mm</td> </tr> <tr> <td>WJ 02 005</td> <td>D=16; H 30 mm</td> </tr> <tr> <td>WJ 02 007</td> <td>D=22; H 20 mm</td> </tr> <tr> <td>WJ 02 008</td> <td>D=25; H 20 mm</td> </tr> </tbody> </table>	kód	popis	WJ 02 001L	D=6; H 31,75 mm	WJ 02 002L	D=8; H 33 mm	WJ 02 003L	D=10; H 38,1 mm	WJ 02 004L	D=12; H 38,1 mm	WJ 02 005	D=16; H 30 mm	WJ 02 007	D=22; H 20 mm	WJ 02 008	D=25; H 20 mm	 	<table border="1"> <thead> <tr> <th>kód</th> <th>popis</th> </tr> </thead> <tbody> <tr> <td>WJ 14 001</td> <td>D=31,75; H 2; B 9,37 mm</td> </tr> <tr> <td>WJ 14 002</td> <td>D=31,75; H 3; B 9,37 mm</td> </tr> <tr> <td>WJ 14 003</td> <td>D=31,75; H 4; B 9,37 mm</td> </tr> <tr> <td>WJ 14 004</td> <td>D=31,75; H 5; B 9,37 mm</td> </tr> <tr> <td>WJ 14 005</td> <td>D=31,75; H 6; B 9,37 mm</td> </tr> <tr> <td>WJ 14 006</td> <td>D=31,75; H 8; B 9,37 mm</td> </tr> <tr> <td>WJ 14 007</td> <td>D=31,75; H 10; B 9,37 mm</td> </tr> <tr> <td>WJ 14 008</td> <td>D=31,75; H 12; B 9,37 mm</td> </tr> <tr> <td>WJ 14 010</td> <td>D=31,75; H 16; B 9,37 mm</td> </tr> </tbody> </table>	kód	popis	WJ 14 001	D=31,75; H 2; B 9,37 mm	WJ 14 002	D=31,75; H 3; B 9,37 mm	WJ 14 003	D=31,75; H 4; B 9,37 mm	WJ 14 004	D=31,75; H 5; B 9,37 mm	WJ 14 005	D=31,75; H 6; B 9,37 mm	WJ 14 006	D=31,75; H 8; B 9,37 mm	WJ 14 007	D=31,75; H 10; B 9,37 mm	WJ 14 008	D=31,75; H 12; B 9,37 mm	WJ 14 010	D=31,75; H 16; B 9,37 mm
			kód	popis																																				
			WJ 02 001L	D=6; H 31,75 mm																																				
			WJ 02 002L	D=8; H 33 mm																																				
			WJ 02 003L	D=10; H 38,1 mm																																				
			WJ 02 004L	D=12; H 38,1 mm																																				
			WJ 02 005	D=16; H 30 mm																																				
			WJ 02 007	D=22; H 20 mm																																				
			WJ 02 008	D=25; H 20 mm																																				
			kód	popis																																				
WJ 14 001	D=31,75; H 2; B 9,37 mm																																							
WJ 14 002	D=31,75; H 3; B 9,37 mm																																							
WJ 14 003	D=31,75; H 4; B 9,37 mm																																							
WJ 14 004	D=31,75; H 5; B 9,37 mm																																							
WJ 14 005	D=31,75; H 6; B 9,37 mm																																							
WJ 14 006	D=31,75; H 8; B 9,37 mm																																							
WJ 14 007	D=31,75; H 10; B 9,37 mm																																							
WJ 14 008	D=31,75; H 12; B 9,37 mm																																							
WJ 14 010	D=31,75; H 16; B 9,37 mm																																							
<table border="1"> <thead> <tr> <th>kód</th> <th>popis</th> </tr> </thead> <tbody> <tr> <td>WJ 01 0028</td> <td>D=3; H 10 mm</td> </tr> <tr> <td>WJ 01 0038</td> <td>D=4; H 10 mm</td> </tr> </tbody> </table>	kód	popis	WJ 01 0028	D=3; H 10 mm	WJ 01 0038	D=4; H 10 mm	 																																	
kód	popis																																							
WJ 01 0028	D=3; H 10 mm																																							
WJ 01 0038	D=4; H 10 mm																																							
 	<table border="1"> <thead> <tr> <th>Obj. číslo</th> <th>popis</th> </tr> </thead> <tbody> <tr> <td>WJ 04 002</td> <td>D=10; H 38 mm</td> </tr> <tr> <td>WJ 04 003</td> <td>D=10; H 50 mm</td> </tr> <tr> <td>WJ 04 004</td> <td>D=12; H 62 mm</td> </tr> <tr> <td>WJ 04 005</td> <td>D=12; H 76 mm</td> </tr> </tbody> </table>	Obj. číslo	popis	WJ 04 002	D=10; H 38 mm	WJ 04 003		D=10; H 50 mm	WJ 04 004	D=12; H 62 mm	WJ 04 005	D=12; H 76 mm	<table border="1"> <thead> <tr> <th>kód</th> <th>popis</th> </tr> </thead> <tbody> <tr> <td>WJ 15 002</td> <td>D=17,46; R 2; B 4,23; H 12,7 mm</td> </tr> <tr> <td>WJ 15 003</td> <td>D=19,05; R 3; B 5,02; H 12,7 mm</td> </tr> <tr> <td>WJ 15 004</td> <td>D=20,62; R 4; B 5,81; H 12,7 mm</td> </tr> <tr> <td>WJ 15 006</td> <td>D=25,4; R 6; B 8,2; H 12,7 mm</td> </tr> <tr> <td>WJ 15 007</td> <td>D=28,6; R 8; B 9,8; H 12,7 mm</td> </tr> <tr> <td>WJ 15 008</td> <td>D=31,7; R 10; B 11,35; H 15,9 mm</td> </tr> <tr> <td>WJ 15 010</td> <td>D=38,1; R 12; B 14,5; H 19,5 mm</td> </tr> <tr> <td>WJ 15 020</td> <td>D=44,45; R 16; B 17,72; H 22,2 mm</td> </tr> </tbody> </table>	kód	popis	WJ 15 002	D=17,46; R 2; B 4,23; H 12,7 mm	WJ 15 003	D=19,05; R 3; B 5,02; H 12,7 mm	WJ 15 004	D=20,62; R 4; B 5,81; H 12,7 mm	WJ 15 006	D=25,4; R 6; B 8,2; H 12,7 mm	WJ 15 007	D=28,6; R 8; B 9,8; H 12,7 mm	WJ 15 008	D=31,7; R 10; B 11,35; H 15,9 mm	WJ 15 010	D=38,1; R 12; B 14,5; H 19,5 mm	WJ 15 020	D=44,45; R 16; B 17,72; H 22,2 mm									
		Obj. číslo	popis																																					
		WJ 04 002	D=10; H 38 mm																																					
		WJ 04 003	D=10; H 50 mm																																					
		WJ 04 004	D=12; H 62 mm																																					
WJ 04 005	D=12; H 76 mm																																							
kód	popis																																							
WJ 15 002	D=17,46; R 2; B 4,23; H 12,7 mm																																							
WJ 15 003	D=19,05; R 3; B 5,02; H 12,7 mm																																							
WJ 15 004	D=20,62; R 4; B 5,81; H 12,7 mm																																							
WJ 15 006	D=25,4; R 6; B 8,2; H 12,7 mm																																							
WJ 15 007	D=28,6; R 8; B 9,8; H 12,7 mm																																							
WJ 15 008	D=31,7; R 10; B 11,35; H 15,9 mm																																							
WJ 15 010	D=38,1; R 12; B 14,5; H 19,5 mm																																							
WJ 15 020	D=44,45; R 16; B 17,72; H 22,2 mm																																							
 	<table border="1"> <thead> <tr> <th>kód</th> <th>popis</th> </tr> </thead> <tbody> <tr> <td>WJ 06 001</td> <td>D=3; R 1,5; H 5 mm</td> </tr> <tr> <td>WJ 06 002</td> <td>D=4; R 2; H 5 mm</td> </tr> <tr> <td>WJ 06 003</td> <td>D=12; R 6; H 8 mm</td> </tr> <tr> <td>WJ 06 006</td> <td>D=12; R 10; H 9,4 mm</td> </tr> </tbody> </table>	kód	popis	WJ 06 001	D=3; R 1,5; H 5 mm	WJ 06 002	D=4; R 2; H 5 mm	WJ 06 003	D=12; R 6; H 8 mm	WJ 06 006	D=12; R 10; H 9,4 mm	 																												
		kód	popis																																					
		WJ 06 001	D=3; R 1,5; H 5 mm																																					
		WJ 06 002	D=4; R 2; H 5 mm																																					
		WJ 06 003	D=12; R 6; H 8 mm																																					
WJ 06 006	D=12; R 10; H 9,4 mm																																							
	<table border="1"> <thead> <tr> <th>kód</th> <th>popis</th> </tr> </thead> <tbody> <tr> <td>WJ 07 001</td> <td>D=13,76; R 2; B 2,38; H 5,38 mm</td> </tr> <tr> <td>WJ 07 002</td> <td>D=15,35; R 3; B 3,17; H 7 mm</td> </tr> <tr> <td>WJ 07 003</td> <td>D=20,94; R 4; B 3,97; H 8 mm</td> </tr> <tr> <td>WJ 07 005</td> <td>D=25,7; R 6; B 6,35; H 11 mm</td> </tr> <tr> <td>WJ 07 006</td> <td>D=28,88; R 8; B 7,96; H 12 mm</td> </tr> <tr> <td>WJ 07 007</td> <td>D=32,05; R 10; B 9,25; H 15 mm</td> </tr> <tr> <td>WJ 07 009</td> <td>D=38,4; R 12; B 12,7; H 18 mm</td> </tr> </tbody> </table>	kód	popis	WJ 07 001	D=13,76; R 2; B 2,38; H 5,38 mm	WJ 07 002	D=15,35; R 3; B 3,17; H 7 mm	WJ 07 003	D=20,94; R 4; B 3,97; H 8 mm	WJ 07 005	D=25,7; R 6; B 6,35; H 11 mm	WJ 07 006	D=28,88; R 8; B 7,96; H 12 mm	WJ 07 007	D=32,05; R 10; B 9,25; H 15 mm	WJ 07 009	D=38,4; R 12; B 12,7; H 18 mm	 																						
		kód	popis																																					
		WJ 07 001	D=13,76; R 2; B 2,38; H 5,38 mm																																					
		WJ 07 002	D=15,35; R 3; B 3,17; H 7 mm																																					
		WJ 07 003	D=20,94; R 4; B 3,97; H 8 mm																																					
WJ 07 005	D=25,7; R 6; B 6,35; H 11 mm																																							
WJ 07 006	D=28,88; R 8; B 7,96; H 12 mm																																							
WJ 07 007	D=32,05; R 10; B 9,25; H 15 mm																																							
WJ 07 009	D=38,4; R 12; B 12,7; H 18 mm																																							
<table border="1"> <thead> <tr> <th>kód</th> <th>popis</th> </tr> </thead> <tbody> <tr> <td>WJ 17002</td> <td>D=13,76; R 2; H 2,38; B 6,35 mm</td> </tr> <tr> <td>WJ17006</td> <td>D=25,7; R 6; H 6,35; B 9,52 mm</td> </tr> <tr> <td>WJ17007</td> <td>D=28,9; R 8; H 7,96; B 10,3 mm</td> </tr> <tr> <td>WJ17008</td> <td>D=32,1; R 10; H 9,52; B 12,3 mm</td> </tr> <tr> <td>WJ17010</td> <td>D=38,4; R 12; H 12,7; B 15,8 mm</td> </tr> </tbody> </table>	kód	popis	WJ 17002	D=13,76; R 2; H 2,38; B 6,35 mm	WJ17006	D=25,7; R 6; H 6,35; B 9,52 mm	WJ17007	D=28,9; R 8; H 7,96; B 10,3 mm	WJ17008	D=32,1; R 10; H 9,52; B 12,3 mm	WJ17010	D=38,4; R 12; H 12,7; B 15,8 mm	<table border="1"> <thead> <tr> <th>kód</th> <th>popis</th> </tr> </thead> <tbody> <tr> <td>WJ 21 005</td> <td>D=19; R 13; H 4,5 mm</td> </tr> </tbody> </table>	kód	popis	WJ 21 005	D=19; R 13; H 4,5 mm																							
	kód	popis																																						
	WJ 17002	D=13,76; R 2; H 2,38; B 6,35 mm																																						
	WJ17006	D=25,7; R 6; H 6,35; B 9,52 mm																																						
	WJ17007	D=28,9; R 8; H 7,96; B 10,3 mm																																						
WJ17008	D=32,1; R 10; H 9,52; B 12,3 mm																																							
WJ17010	D=38,4; R 12; H 12,7; B 15,8 mm																																							
kód	popis																																							
WJ 21 005	D=19; R 13; H 4,5 mm																																							

			
kód	popis	kód	popis
WJ 09 001	D=31,5; H 2; B 10,7 mm	WJ 31 002	D=26; R 3,17; B 6,35; H 9,7 mm
WJ 09 002	D=31,5; H 3; B 10,7 mm	WJ 31 005	D=35; R 5,6; B 11,1; H 15,7 mm
WJ 09 003	D=31,5; H 4; B 10,7 mm		
WJ 09 005	D=31,5; H 6; B 10,7 mm	kód	popis
WJ 09 006	D=31,5; H 8; B 10,7 mm	WJ 33 001	D=26; R 2,38; B 6,34; H 9,52 mm
WJ 09 007	D=31,5; H 10; B 10,7 mm	WJ 33 003	D=32; R 3,96; B 9,52; H 12,9 mm
WJ 09 008	D=31,5; H 12; B 10,7 mm		
		kód	popis
WJ 10 005	D=35; α 45°; B 19,05 mm	WJ 7703	D = 16 mm
WJ 10 006	D=40; α 45°; B 19,05 mm		
WJ 10 007	D=44; α 45°; B 22,2 mm		
		kód	popis
WJ 12 003	D=10; H 9,25 mm; 2x α 90°		
WJ 12 004	D=12; H 12,7 mm; 2x α 90°		

Ložiská	kód	popis	
	WJ 9701	D 9,5; d 4,76; š 3,2 mm	
	WJ 9702	D 12,7; d 4,76; š 5 mm	
	WJ 9704	D 13; d 6; š 5 mm	
	WJ 9705	D 15; d 6; š 5 mm	
	WJ 9710	D 19; d 4,76; š 7 mm	
	WJ 9715	D 22; d 8; š 7 mm	
	WJ 9719	D 28; d 12; š 8 mm	

sukovník HSS			zátkovník HSS			záhlbník nástrčný			dlabací vrták 2-britý		
											
						90° x 10 mm 90° x 20 mm					
kód	popis		kód	popis		kód	popis		popis		
07015	Ø 15 mm		07320	Ø 20 mm		01020	Ø 2 x 20		Ø 6 x 10 x 40 x 105 mm		
07016	Ø 16 mm		07325	Ø 25 mm		01030	Ø 3 x 20		Ø 7 x 10 x 45 x 110 mm		
07020	Ø 20 mm		07330	Ø 30 mm		01040	Ø 4 x 20		Ø 8 x 10 x 50 x 115 mm		
07022	Ø 22 mm		07335	Ø 35 mm		01050	Ø 5 x 20		Ø 10 x 10 x 60 x 125 mm		
07025	Ø 25 mm		07340	Ø 40 mm		01060	Ø 6 x 20		Ø 12 x 16 x 70 x 135 mm		
07026	Ø 26 mm		07345	Ø 45 mm		01070	Ø 7 x 25		Ø 14 x 16 x 80 x 145 mm		
07028	Ø 28 mm		07350	Ø 50 mm		01080	Ø 8 x 25		Ø 15 x 16 x 85 x 150 mm		
07030	Ø 30 mm		07360	Ø 60 mm		01090	Ø 9 x 25		Ø 16 x 16 x 90 x 155 mm		
07032	Ø 32 mm					01100	Ø 10 x 25		Ø 18 x 16 x 100 x 165 mm		
07034	Ø 34 mm					01120	Ø 12 x 30		Ø 20 x 16 x 110 x 175 mm		
07035	Ø 35 mm										
07038	Ø 38 mm										
07040	Ø 40 mm										
07042	Ø 42 mm										
07045	Ø 45 mm										
07050	Ø 50 mm										
07060	Ø 60 mm										

vykružo			kód		priemer	predznačovák		
			WJ7011015		15 mm			
			WJ7011020		20 mm			
			WJ7011025		25 mm			
			WJ7011030		30 mm			
			WJ7011035		35 mm			
			WJ7011040		40 mm			
kód	popis					popis		
WJD20	Ø 20-120 mm, max. hĺbka 35 mm					07606 Ø 6		
						07608 Ø 8		
						07610 Ø 10		
						07612 Ø 12		

							
kód		kód		kód		kód	
WJ 640002N		WJ 121001N		WJ 77004N		WJ 126003Z2N	

Vrták na konfirmátovú skrutku			
			
kód	popis	vrták	
KONF005	7 x 50 mm	5 mm	

Vrták dvojdielny na konfirmátovú skrutku			
			
kód	popis	vrták	
06420	7 x 50 mm	4,2 mm	
06500	7 x 50 mm	5 mm	

Vrták na konfirmáty, PL			
			
kód	popis		
06550	5 x 50 mm		
06750	7 x 50 mm		

Vrták na konfirmáty, CZ



kód	popis	
05540	5 x 40 mm	
05550	5 x 50 mm	
05650	6,3 x 50 mm	
05660	6,3 x 60 mm	
05750	7 x 50 mm	
05770	7 x 70 mm	